



fun abounds, inc.
 114 Venice
 Sugar Land, TX. 77478
 855-226-8637 phone
 281-265-0043 Fax
 Leigh Walden, President
 lwalden@fabplaygrounds.com
 www.fabplaygrounds.com

Estimate

Date	Estimate #
2/16/2023	9316

Norman Cue
 Playground Specialist
 North Houston/East Texas
 norman@fabplaygrounds.com
 832-808-9600

We are pleased to provide this estimate for

City of League City
 Cameron Parker
 400 S Kansas Ave
 League City, TX 77573

Ship to:

2630 Cemetary Road
 Santa Fe, Texas 77517
 USA

Rep	Terms	Project
NGC	30% deposit requ...	Countryside Park

Item	Description	Qty	Rate	Total
Buyboard Number	Buyboard 679-22		0.00	0.00
Pacific Outdoor Products	Exercise Zone Equipment, Surfacing Material, Installation, and Freight		9,720.00	9,720.00T
Bond Flex	StayFIT Fitness Systems FE-1124 Bond Flex Poured in Place - 50% Black - 3" (528 sqft)	528	26.16288	13,814.00T
Excavation	Excavation - 22x24 space (528 sqft)		2,106.00	2,106.00T
Compacted Aggregate	Compacted Stone Aggregate Base; approx. 4" thick		2,104.00	2,104.00T
Concrete Border	12" High Extruded Concrete Border (6" Wide)		5,976.00	5,976.00T
Drainage	Drainage		5,293.00	5,293.00T
Installation	Installation of Equipment		5,122.00	5,122.00
	Subtotal of Exercise Zone			44,135.00
Berliner	Playground Equipment, Installation, Surfacing Material, and Freight		23,672.00	23,672.00T
Berliner	Quadrifol Base		3,689.00	3,689.00T
Freight	Eddie.01		3,451.00	3,451.00T
	Equipment Freight (Truckload)			

Thank you for allowing us to submit this proposal.

Subtotal

**PLEASE NOTE: Order will be placed upon receipt of signed quote or purchase order, color selections, and down payment.
 Thank you! We appreciate the opportunity to earn your business!**

Sales Tax..

Total

City of Houston WBE
 (Women's Business Enterprise)
 Certificate #20-2-11596

Signature

We are proud of a job well done and may spotlight your project on our social media. If we do not have your permission to do so, please notify us. Thank you!



fun abunds, inc.
 114 Venice
 Sugar Land, TX. 77478
 855-226-8637 phone
 281-265-0043 Fax
 Leigh Walden, President
 lwalden@fabplaygrounds.com
 www.fabplaygrounds.com

Estimate	
Date	Estimate #
2/16/2023	9316

Norman Cue
 Playground Specialist
 North Houston/East Texas
 norman@fabplaygrounds.com
 832-808-9600

We are pleased to provide this estimate for

City of League City
 Cameron Parker
 400 S Kansas Ave
 League City, TX 77573

Ship to:

2630 Cemetery Road
 Santa Fe, Texas 77517
 USA

Rep	Terms	Project
NGC	30% deposit requ...	Countryside Park

Item	Description	Qty	Rate	Total
Installation	Installation of Equipment		7,786.00	7,786.00
EWF - Installation Cost ...	Installation only of EWF and Geotextile (EWF pricing on separate line item)	37	35.86486	1,327.00T
EWF - Material only und...	EWF - Material only. Under 50 yds - 40yds minimum		1,176.00	1,176.00T
EWF - Freight	EWF Freight - includes fuel surcharge		673.00	673.00T
	Subtotal of Plaground Area			41,774.00
Buyboard	Buyboard Discount - 7% off Equipment		-2,596.00	-2,596.00T
Note	Pricing is for the above listed equipment only, and does not include additional insured addendum, additional insurance, storage, security, or any applicable taxes, bonds, additional insurance or permits. Orders canceled after an order has been received, a minimum of 5% restocking to full replacement pricing of item will be required. Price valid for 30 days.		0.00	0.00T

Thank you for allowing us to submit this proposal.

Subtotal

PLEASE NOTE: Order will be placed upon receipt of signed quote or purchase order, color selections, and down payment. Thank you! We appreciate the opportunity to earn your business!

Sales Tax..

Total

City of Houston WBE
 (Women's Business Enterprise)
 Certificate #20-2-11596

Signature

We are proud of a job well done and may spotlight your project on our social media. If we do not have your permission to do so, please notify us. Thank you!



fun abunds, inc.
 114 Venice
 Sugar Land, TX. 77478
 855-226-8637 phone
 281-265-0043 Fax
 Leigh Walden, President
 lwalden@fabplaygrounds.com
 www.fabplaygrounds.com

Estimate

Date	Estimate #
2/16/2023	9316

Norman Cue
 Playground Specialist
 North Houston/East Texas
 norman@fabplaygrounds.com
 832-808-9600

We are pleased to provide this estimate for

City of League City
 Cameron Parker
 400 S Kansas Ave
 League City, TX 77573

Ship to:

2630 Cemetary Road
 Santa Fe, Texas 77517
 USA

Rep	Terms	Project
NGC	30% deposit requ...	Countryside Park

Item	Description	Qty	Rate	Total
Schedule	There are times due to weather or unforeseen circumstances that we might have to reschedule. In an effort to provide excellent customer service we will notify you should rescheduling be necessary. We appreciate your understanding as we pride ourselves on providing attention and detail to every project.		0.00	0.00T
Site Access	If site access is restricted in any way there could be an additional charge.		0.00	0.00T
Nondisclosed underground	We make every effort to ensure that we are working in areas free of utilities. In the event an object is disturbed or damaged and the client has failed to make us aware of their utilities it will be the Client's responsibility. We HIGHLY recommend a private locate service scan the site BEFORE we arrive on site.		0.00	0.00T
Credit Cards	Payments made with credit cards will require an additional 3.10% service fee.		0.00	0.00T

Thank you for allowing us to submit this proposal.

Subtotal

**PLEASE NOTE: Order will be placed upon receipt of signed quote or purchase order, color selections, and down payment.
 Thank you! We appreciate the opportunity to earn your business!**

Sales Tax..

Total

City of Houston WBE
 (Women's Business Enterprise)
 Certificate #20-2-11596

Signature

We are proud of a job well done and may spotlight your project on our social media. If we do not have your permission to do so, please notify us. Thank you!



fun abounds, inc.
 114 Venice
 Sugar Land, TX. 77478
 855-226-8637 phone
 281-265-0043 Fax
 Leigh Walden, President
 lwalden@fabplaygrounds.com
 www.fabplaygrounds.com

Estimate

Date	Estimate #
2/16/2023	9316

Norman Cue
 Playground Specialist
 North Houston/East Texas
 norman@fabplaygrounds.com
 832-808-9600

We are pleased to provide this estimate for

City of League City
 Cameron Parker
 400 S Kansas Ave
 League City, TX 77573

Ship to:

2630 Cemetary Road
 Santa Fe, Texas 77517
 USA

Rep	Terms	Project
NGC	30% deposit requ...	Countryside Park

Item	Description	Qty	Rate	Total
Finance Charge	Accounts not paid within 30 days of the date of the invoice are subject to a 1.5% finance charge.		0.00	0.00T
Force Majeure	No Party to this Agreement shall be responsible for any delays or failure to perform any obligation under this Agreement due to acts of God, outbreaks, epidemic/pandemic or the spreading of disease, contagion, strikes, or other disturbances, including, without limitation, war, insurrection, embargoes, governmental restrictions, acts of governments or governmental authorities, and any other cause beyond the control of such party. During an event of force majeure, the Parties' duty to perform obligations shall be re-assessed.		0.00	0.00

Thank you for allowing us to submit this proposal.

Subtotal

**PLEASE NOTE: Order will be placed upon receipt of signed quote or purchase order, color selections, and down payment.
 Thank you! We appreciate the opportunity to earn your business!**

Sales Tax..

Total

City of Houston WBE
 (Women's Business Enterprise)
 Certificate #20-2-11596

Signature

We are proud of a job well done and may spotlight your project on our social media. If we do not have your permission to do so, please notify us. Thank you!



fun abounds, inc.
 114 Venice
 Sugar Land, TX. 77478
 855-226-8637 phone
 281-265-0043 Fax
 Leigh Walden, President
 lwalden@fabplaygrounds.com
 www.fabplaygrounds.com

Estimate	
Date	Estimate #
2/16/2023	9316

Norman Cue
 Playground Specialist
 North Houston/East Texas
 norman@fabplaygrounds.com
 832-808-9600

We are pleased to provide this estimate for

City of League City
 Cameron Parker
 400 S Kansas Ave
 League City, TX 77573

Ship to:

2630 Cemetary Road
 Santa Fe, Texas 77517
 USA

Rep	Terms	Project
NGC	30% deposit requ...	Countryside Park

Item	Description	Qty	Rate	Total
HUB Certificate	Certificate/VID Number: 1364766562200 File/Vendor Number: 496631 Approval Date: 25-MAR-2020 Scheduled Expiration Date: 25-MAR-2024		0.00	0.00T

Thank you for allowing us to submit this proposal.	Subtotal	\$83,313.00
PLEASE NOTE: Order will be placed upon receipt of signed quote or purchase order, color selections, and down payment. Thank you! We appreciate the opportunity to earn your business!	Sales Tax..	\$0.00
	Total	\$83,313.00

City of Houston WBE
 (Women's Business Enterprise)
 Certificate #20-2-11596

Signature _____

We are proud of a job well done and may spotlight your project on our social media. If we do not have your permission to do so, please notify us. Thank you!

Univers

Quadrifol Base Product Specifications



Published: November 2019

Quadrifol Base

Univers showcases all see-through outer frame structures with three-dimensional nets inside. All tensioning points are provided with the patented AstemTT tensioning system. This ensures that no technical connecting elements or rope loops are located in the play area.

The Quadrifol Base is a climbing web stretched across metal arcs. It offers endless climbing fun in 3-D for children of all ages!

71.133.000

Product Family	Univers
Length x Width x Height (m) Length x Width x Height ("")	4,4 x 4,4 x 3,5 14-5 x 14-5 x 11-4
Protective Surfacing Area acc. to DIN EN 1176 (m) Protective Surfacing Area acc. to ASTM/CSA (m) Protective Surfacing Area acc. to ASTM/CSA ("")	7,4 x 7,4 8,1 x 8,1 26-5 x 26-5
Fall Height acc. to EN 1176 (m) Fall Height acc. to ASTM/CSA ("")	1,3 6-0
Age	5-12
Minimum Space required acc. to DIN EN 1176 (m ²) Minimum Space required acc. to ASTM 1487 (ft ²)	48.13 618.4
Number of Foundations	4
Concrete Volume C20/C25 (ft ³)	191
Number of skilled Installers required	3
Installation Time without Foundation	6 hours
Dimensions of largest Part ("")	2-0 x 11-10 x 0-8
Weight of heaviest Part (lbs)	220.5
Shipping Volume (ft ³)	148.4
Total Weight (lbs)	1,329.4
Spare Part Guarantee	Lifelong
Certified acc. to EN 1176	Z2 010256 0282

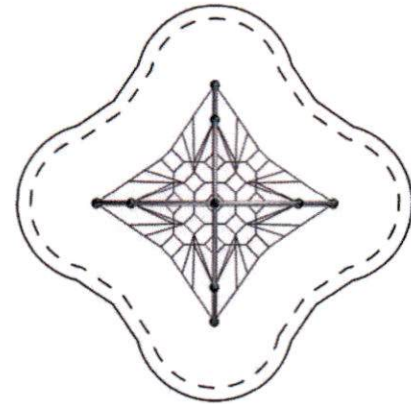
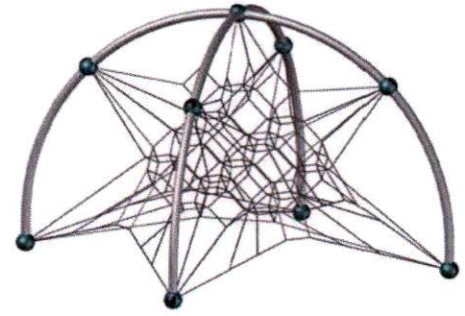

Technical Data

The following text can also be used for tenders.

Bent tubes:

Galvanized steel post Ø 5 ¼", on demand with color finish including solvent-free epoxy-/polyester-process powder coating.

Balls:

Framework[®]-aluminum ball connectors, Ø 9 13/16"; anticorrosion treatment and color finish: sandblasting and epoxy-/polyester-powdercoating; incorporating the patented Astem TT[®] tensioning system, securely closed with durable ebonite caps.

Ropes:

U-Rope[®]-round strand ropes with galvanized steel cores, Ø 1 3/16"; external strands are covered with high abrasion-resistant and UV-resistant polyester-yarn (no Polypropylene).

Spatial net:

Rope crossing points are localized with durable, forged aluminum-alloy cloverleaf rings, aluminum-alloy ball-knots, T-connectors and barrel-ferrule (no plastic connections) in situ-replaceable rope strands.

FE - 1124

Safe use area: 22' x 24'

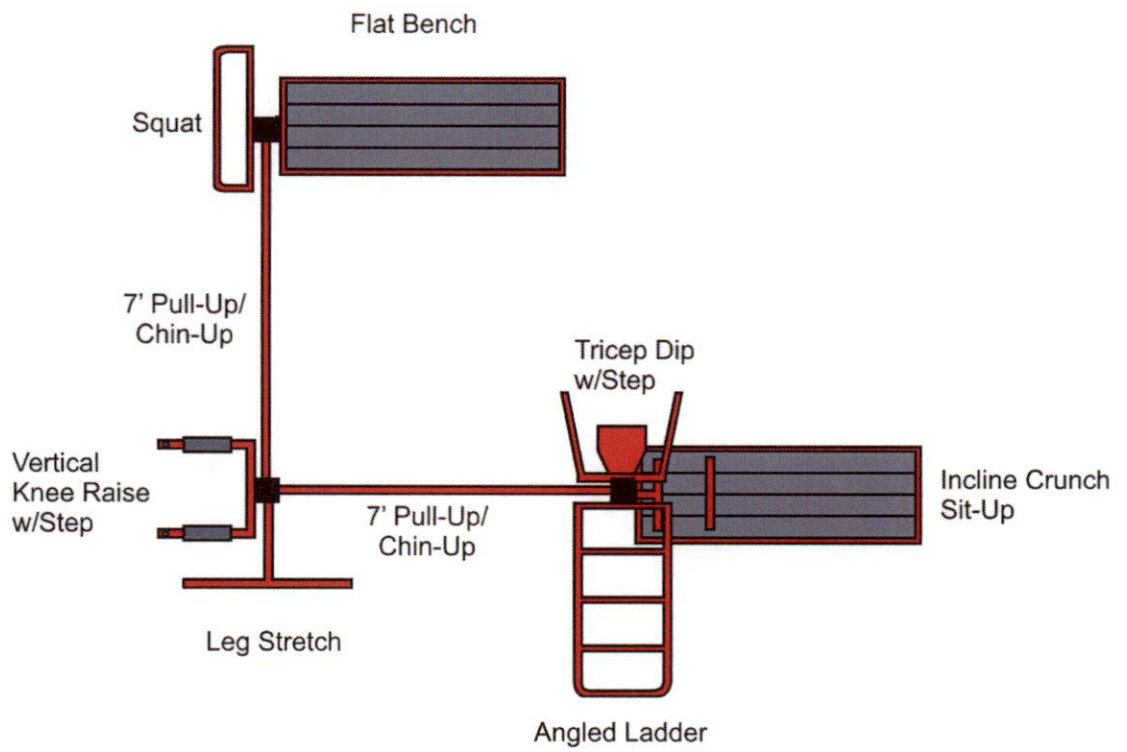

Eddie.01 – Product Specification

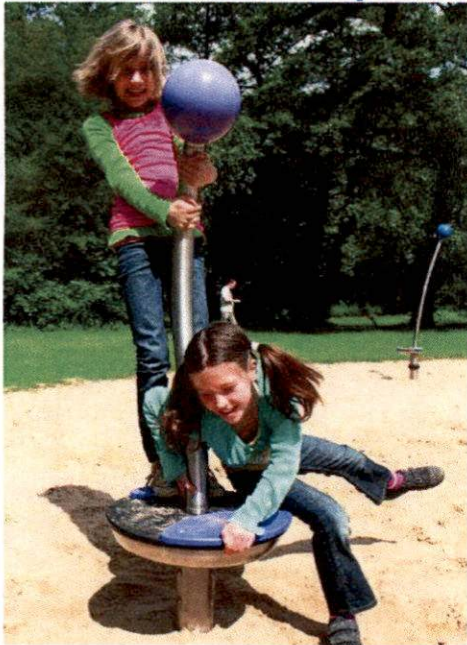

Eddie.01

The Eddie.01 stands up straight for small and big kids who love to go for a spin. With a body and a stem made out of stainless steel, it is weatherproof and looks stylish. The HD PE-platform, with its second colour inlays plus the matching top ball make it look cool. Fun, style and coolness, all rolled into one Playpoint!

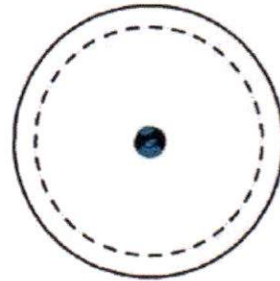

Eddie.01 – at a glance.

Product Family:	Playpoints	Number of Foundations:	1 pc.
Item Number:	90.260.101	Concrete Volume C20/C25:	0.15 m ³ (5.3 ft ³)
Children's Age:	3+	Number of skilled installers required:	2
Fall Height (DIN EN 1176):	0.4 m (1'-4")	Installation Time without foundation:	2 hours
Length x Width x Height:	0.5 m x 0.5 m x 1.5 m (1'-8" x 1'-8" x 5'-0")	Dimensions of largest part:	0.5 m x 0.5 m x 1.9 m (1'-8" x 1'-8" x 6'-3")
Protective Surfacing Area (DIN EN 1176):	3.5 m x 3.5 m	Weight of the heaviest part:	60 kg (133 lbs)
Protective Surfacing Area (ASTM 1487):	4.2 m x 4.2 m (13'-10" x 13'-10")	Shipping Volume:	1.1 m ³ (39 ft ³)
Minimum space required DIN EN 1176:	9.6 m ²	Shipping Weight:	75 kg (166 lbs)
Minimum space required ASTM 1487:	13.6 m ² (147 ft ²)	Spare part guarantee:	Lifelong
		Certificate according to DIN EN 1176:	No.: Z2 15 07 10256 234 TÜV Product Service

Technical Data.

The following text can also be used for tenders.

Turntable:

Stainless steel plate Ø 494 mm (1'-8"), covered with HDPE panels

Tubes:

Stainless steel tube, Ø 60.3 mm (2-3/8") Frameworx®-aluminum ball connector; Ø 200 mm (8"); anti-corrosion treatment and color finish: sandblasting and solvent-free zinc-/ epoxy-/ polyester-process; securely closed with durable EPDM- caps

Stand:

Stainless steel Picolino swivel stand with fully encapsulated bearing

Covering:

Antiskid HDPE panels, 19 mm (3/4"), bolted on the turntable



Berliner

Berliner Seilfabrik
Play Equipment Corporation
96 Brookfield Oaks Drive, Suite 140
Greenville, SC 29607

T + 1 864 627 1092
F + 1 864 627 1178

www.berliner-playequipment.com
info@berliner-seilfabrik.com

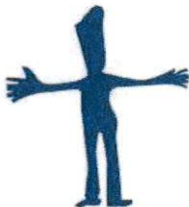

Berliner
Berliner Seilfabrik
Play Equipment Corporation
96 Brookfield Oaks Drive, Suite 140
Greenville, SC 29607

T + 1 864 627 1092
F + 1 864 627 1178

www.berliner-playequipment.com
info@berliner-seilfabrik.com

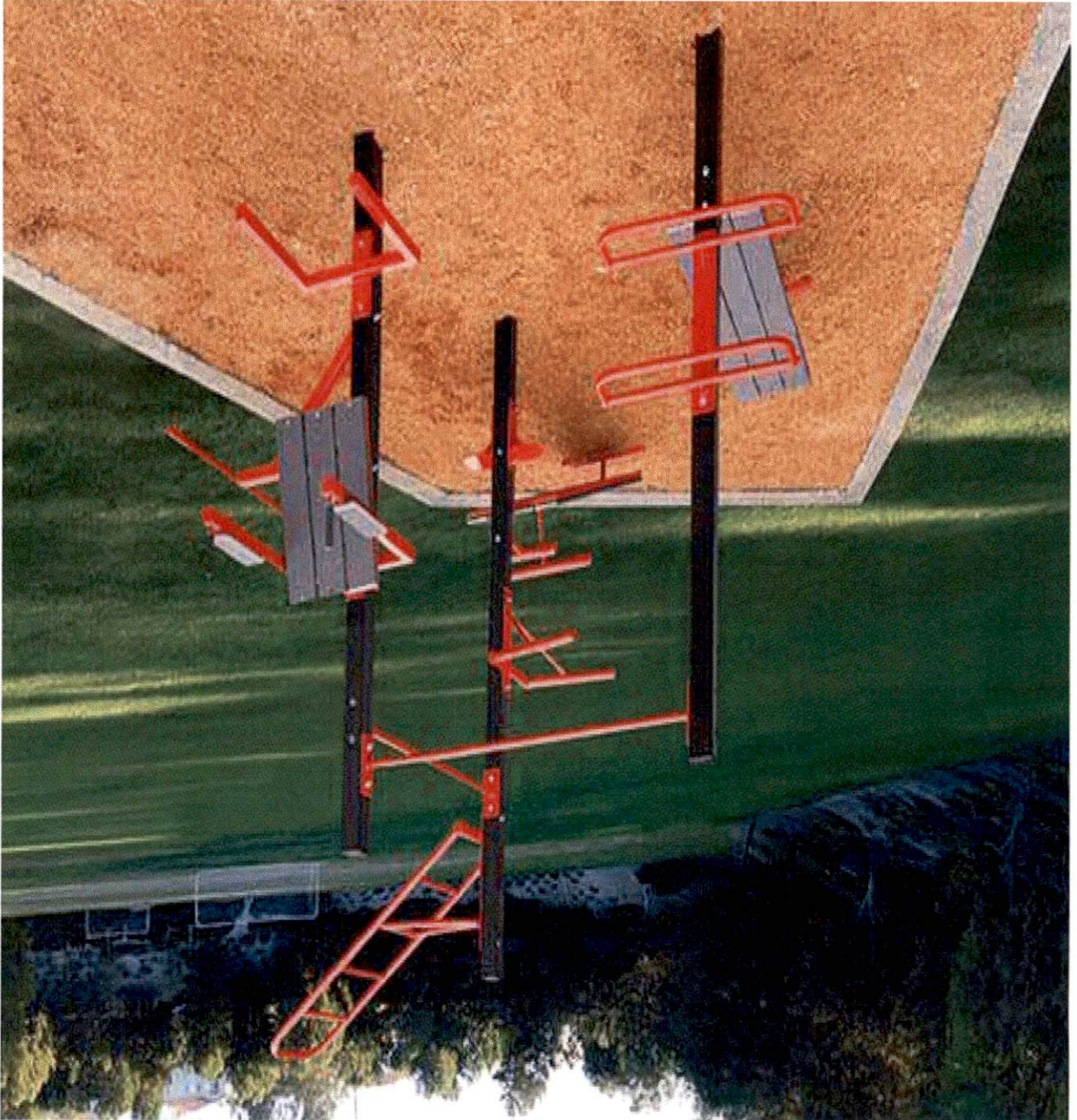



Miracle Recreation Equip. Co.
878 E. US Hwy 60
Monett, MO 65708
1-888-458-2752

QUOTE: R0088232105

Project: R0088_45000540623_01

Prepared For:

Rusty Bolen

City of League City
300 W. Walker
League City, TX 77535
(281) 554-1159 (phone)
rusty.bolen@leaguecitytx.gov

Project Name & Location:

Attn: Countryside Park
Cameron Parker

Prepared by:

May Recreation Equipment & Design
LP

3 Sunspree Place
The Woodlands, TX 77382
(281) 288-1412 (phone)
(281) 288-0043 (fax)
jeff@mayrecreation.com

Ship To Address:

Matt Wanner
Matt Wanner
6016 Whispering Lakes Dr
Katy, TX 77493
(713) 725-9332 (phone)
Matt@mayrecreation.com

End User:

Quote Number: R0088232105
Quote Date: 4/13/2023
Valid For: 30 Days From Quote Date

PlayArea_Q1

Product line: Freestanding
Age group:

Components

Part Number	Description	Qty	Weight	Unit Price	Total
NF032123	No Fault PIP Surfacing 585 sf @ 3.5"	1	0.00	12,663.00	12,663.00

PlayArea_1

Product line: Freestanding
Age group: 13+

Components

Part Number	Description	Qty	Weight	Unit Price	Total
925920Z	TOUCH UP PAINT KIT - FREESTANDING (NO PRICE)	1	0.00	0.00	0.00
OTSM3	OTS GROUP FIT 3	1	1,413.00	13,115.00	13,115.00

Additional Items

Part Number	Description	Qty	Weight	Unit Price	Total
925961	THUMB DRIVE 2GB - MREC	1	0.00	0.00	0.00
926021	MREC CARD F/THUMB DRIVE	1	0.00	0.00	0.00
INSTALL BOOK	INSTALL BOOK FOR PP ORDERS	1	0.00	0.00	0.00

Parts By Other

Part Number	Description	Qty	Weight	Unit Price	Total
242444	Fibar System 112 1250 sf 63cy 1 mat	1	0.00	2,798.00	2,798.00
EP-CN-AN1 302	Elephant Play Medium Dome	1	0.00	36,561.94	36,561.94
GPHCOLCC S	Concrete Slab for Fitness Equipment	1	0.00	8,400.00	8,400.00

Totals:

Equipment Weight:	1,413.00 lbs
Equipment List:	\$25,778.00
Discount Amount:	-\$3,278.75
Equipment Price:	\$22,499.25
Freight:	\$1,805.81
Installation:	\$12,935.00
Products by Other:	\$47,759.94
SubTotal:	\$85,000.00
Grand Total:	\$85,000.00

Notes:

Buy Board Proposal #679-22

This Quote shall not become a binding contract until signed and delivered by both Customer and Miracle Recreation Equipment Company ("Miracle"). Sales Representative is not authorized to sign this Quote on behalf of Miracle or Customer, and signed Quotes cannot be accepted from Sales Representative. To submit this offer, please sign below and forward a complete signed copy of this Quote directly to "Miracle Sales Administration" via fax (417) 235-3551 or email: orders@miraclerec.com. Upon acceptance, Miracle will return a fully-signed copy of the Quote to Customer (with copy to Sales Representative) via fax or email.

THIS QUOTE IS LIMITED TO AND GOVERNED BY THE TERMS CONTAINED HEREIN. Miracle objects to any other terms proposed by Customer, in writing or otherwise, as material alterations, and all such proposed terms shall be void. Customer authorizes Miracle to ship the Equipment and agrees to pay Miracle the total amount specified. Shipping terms are FOB the place of shipment via common carrier designated by Miracle. Payment terms are Net-30 days from invoice date with approved credit and all charges are due and payable in full at PO Box 734154, Dallas, TX 75373-4154, unless notified otherwise by Miracle in writing. Customer agrees to pay all additional service charges for past due invoices. Customer must provide proper tax exemption certificates to Miracle, and shall promptly pay and discharge all otherwise applicable taxes, license fees, levies and other impositions on the Equipment at its own expense. Purchase orders and payments should be made to the order of Miracle Recreation Equipment Company.

Quote Number: R0088232105 Quote Date: 4/13/2023 Equipment: \$25,778.00 Grand Total: \$85,000.00

CUSTOMER HEREBY SUBMITS ITS OFFER TO PURCHASE THE EQUIPMENT ACCORDING TO THE TERMS STATED IN THIS QUOTE AND SUBJECT TO FINAL APPROVAL BY MIRACLE.

Submitted By Printed Name and Title Date
THE FOREGOING QUOTE AND OFFER ARE HEREBY APPROVED AND ACCEPTED BY MIRACLE RECREATION EQUIPMENT

By:

Date:

ADDITIONAL TERMS & CONDITIONS OF SALE

- 1. Use & Maintenance.** Customer agrees to regularly inspect and maintain the Equipment, and to provide, inspect and maintain appropriate safety surfacing under and around the Equipment, in accordance with Miracle's product literature and the most current Consumer Product Safety Commission Handbook for Public Playground Safety.
- 2. Default, Remedies & Delinquency Charges.** Customer's failure to pay any invoice when due, or its failure to otherwise comply with the terms of this Quote, shall constitute a default under all unsatisfied invoices ("Event of Default"). Upon an Event of Default, Miracle shall have all remedies available to it at law or equity, including, without limitation, all remedies afforded a secured creditor under the Uniform Commercial Code. Customer agrees to assist and cooperate with Miracle to accomplish its filing and enforcement of mechanic's or other liens with respect to the Equipment or its location or its repossession of the Equipment, and Customer expressly waives all rights to possess the Equipment after an Event of Default. All remedies are cumulative and not alternative, and no exercise by Miracle of a remedy will prohibit or waive the exercise of any other remedy. Customer shall pay all reasonable attorneys fees plus any costs of collection incurred by Miracle in enforcing its rights hereunder. Subject to any limitations under law, Customer shall pay to Miracle as liquidated damages, and not as a penalty, an amount equal to 1.5% per month of any payment that is delinquent in such month and is not received by Miracle within ten (10) days after the date on which due.
- 3. Limitation of Warranty/ Indemnity.** MIRACLE MAKES NO EQUIPMENT WARRANTIES EXCEPT FOR THOSE STANDARD WARRANTIES ISSUED WITH THE EQUIPMENT, WHICH ARE INCORPORATED HEREIN BY THIS REFERENCE. MIRACLE SPECIFICALLY DISCLAIMS ANY IMPLIED WARRANTY OF MERCHANTABILITY OR FITNESS FOR A PARTICULAR PURPOSE AND ANY LIABILITY FOR INCIDENTAL OR CONSEQUENTIAL DAMAGES. CUSTOMER AGREES TO DEFEND, INDEMNIFY AND SAVE MIRACLE HARMLESS FROM ALL CLAIMS OF ANY KIND FOR DAMAGES OF ANY KIND ARISING OUT OF CUSTOMERS ALTERATION OF THE EQUIPMENT, ITS FAILURE TO MAINTAIN THE EQUIPMENT, ITS FAILURE TO PROPERLY SUPERVISE EQUIPMENT USE, OR ITS FAILURE TO PROVIDE AND MAINTAIN APPROPRIATE TYPES AND DEPTHS OF SAFETY SURFACING BENEATH AND AROUND THE EQUIPMENT IN ACCORDANCE WITH MIRACLES INSTALLATION AND OWNERS MANUALS AND THE MOST CURRENT CONSUMER PRODUCT SAFETY COMMISSION HANDBOOK FOR PUBLIC PLAYGROUND SAFETY.
- 4. Restrictions.** Until all amounts due hereunder are paid in full, Customer shall not: (i) permit the Equipment to be levied upon or attached under any legal process; (ii) transfer title to the Equipment or any of Customer's rights therein; or (iii) remove or permit the removal of the Equipment to any location not specified in this Quote.
- 5. Purchase Money Security Interest.** Customer hereby grants, pledges and assigns to Miracle, and Miracle hereby reserves a purchase money security interest in, the Equipment in order to secure the payment and performance in full of all of Customer's obligations hereunder. Customer agrees that Miracle may file one or more financing statements, in order to allow it to perfect, acquire and maintain a superior security interest in the Equipment.
- 6. Choice of Law and Jurisdiction.** All agreements between Customer and Miracle shall be interpreted, and the parties' obligations shall be governed, by the laws of the State of Missouri without reference to its choice of law provisions. Customer hereby consents to the personal jurisdiction of the state and federal courts located in the city and county of St. Louis, Missouri.
- 7. Title; Risk of Loss; Insurance.** Miracle Retains full title to all Equipment until full payment is received by Miracle. Customer assumes all risk of loss or destruction of or damage to the Equipment by reason of theft, fire, water, or any other cause, and the occurrence of any such casualty shall not relieve the Customer from its obligations hereunder and under any invoices. Until all amounts due hereunder are paid in full, Customer shall insure the Equipment against all such losses and casualties.
- 8. Waiver; Invalidity.** Miracle may waive a default hereunder, or under any invoice or other agreement between Customer and Miracle, or cure such a default at Customer's expense, but shall have no obligation to do either. No waiver shall be deemed to have taken place unless it is in writing, signed by Miracle. Any one waiver shall not constitute a waiver of other defaults or the same kind of default at another time, or a forfeiture of any rights provided to Miracle hereunder or under any invoice. The invalidity of any portion of this Quote shall not affect the force and effect of the remaining valid portions hereof.
- 9. Entire Agreement; Amendment; Binding Nature.** This fully-executed Quote, as supplemented by Change Orders and invoices containing exact amounts of estimates provided herein, constitutes the complete and exclusive agreement between the parties. A Change Order is a written instrument signed by the Customer and Miracle stating their agreement as to any amendment in the terms of this Quote. Customer acknowledges that Change Orders may result in delays and additional costs. The parties agree that all Change Orders shall include appropriate adjustments in price and time frames relating to any requested amendments. Upon full execution, this Quote shall be binding upon and inure to the benefit of the parties and their successors and assigns.
- 10. Counterparts; Electronic Transmission.** This Quote, any invoice, and any other agreement between the parties, may be executed in counterparts, each of which shall constitute an original. The facsimile or other electronic transmission of any signed original document and

4/13/2023

Page 3 of 4

QUOTE: R0088232105

retransmission of any signed facsimile or other electronic transmission shall be the same as the transmission of an original. At the request of either party, the parties will confirm facsimile or other electronically transmitted signatures by signing an original document.

Rev E 021815

4/13/2023

QUOTE: R0088232105

Page 4 of 4

Medium Dome

EP-CN-ANS1302 (ASTM & CSA)

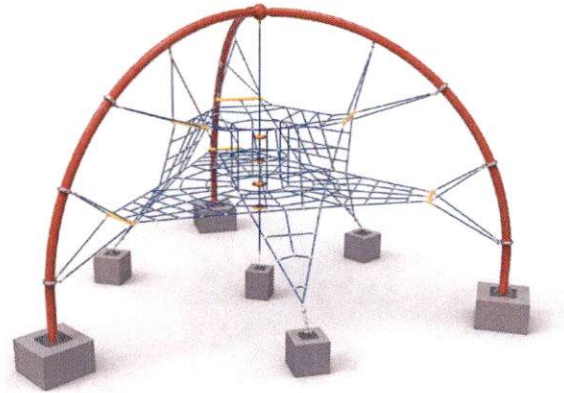

CHARACTERISTICS

Age Group : 5-12 years old
 Height (structure) : 12'-5" (3,78m)
 Hauteur de chute : 10'-3" (3,12m)
 Capacity : 30
 Safety Zone US (ASTM) and Canada (CSA) : 35'-5" x 35'
 (10,80m x 10,68m)

MATERIALS

Structure : galvanized and powder coated steel;
 Cables : braided UV-resistant nylon over seven (7) galvanized steel cables; 0,8" (20mm) diameter;
 Net Accessories : HDPE plastic;
 Mechanical Assembly : seamless 2" (51mm) diameter aluminum crimped cross joint castings.

ANCHOR TYPE

Concrete base footing or autostable steel structure.

PLAY VALUE

The Medium Dome provides challenging play either solo or in group. The arch shape allows for children to climb and to observe while socializing. It is a place where they gather and develop their motor skills by tacking different routes each time.

AVAILABLE COLORS - PAINT



AVAILABLE COLORS - CABLES

